

**Sculptural Hook Round Mirror**  
**MIROIR D'ENTRÉE SCULPTURAL PETIT**  
**ESPEJO PARA LA ENTRADA SCULPTURAL PEQUEÑO**

### ENGLISH

- Do not dispose of any packaging or contents of the shipping carton until assembly is completed to avoid accidentally discarding small parts or hardware.
- This unit must be fixed to the wall.
- Enclosed fasteners are for drywall only.
- Use fixing devices suitable for the walls in your home. Please contact your hardware store if you are uncertain about what type of screw or hardware to use.

### FRANÇAIS

- Ne jetez rien des produits d'emballage et du contenu de la boîte jusqu'à ce que l'assemblage soit terminé, afin d'éviter de jeter par mégarde de petites pièces ou des morceaux.
- Cet article doit être fixé au mur.
- Les attaches fournies sont pour le cloison sèche seulement.
- L'utilisation des dispositifs de fixation qui sont appropriés pour votre domicile. Communiquer avec la quincaillerie locale en cas d'incertitude concernant le type de vis ou le matériel à utiliser.

### ESPAÑOL

- Para evitar desechar accidentalmente las partes pequeñas o las piezas de ferretería, no tirar el embalaje o contenido de la caja hasta que el ensamblaje esté completo.
- Esta unidad se debe fijar a la pared.
- Los sujetadores incluidos son solamente para muro seco.
- Utilizar dispositivos de fijación aptos para las paredes de su casa. Comuníquese con su ferretería si no está seguro sobre el tipo de tornillo o herraje que debe usar.

---

#### Care Instructions:

- Dust often using a clean, soft, dry and lint-free cloth.
- When blot spills, wipe with a clean, damp cloth immediately.
- We do not recommend the use of chemical cleansers, abrasives or furniture polish on our lacquered finish.
- Hardware may loosen over time. Periodically check to make sure all connections are tight. Re-tighten if necessary.

#### Instructions d'entretien :

- Éponger régulièrement avec un chiffon propre, doux et non pelucheux.
- Éponger immédiatement les liquides renversés et essuyer à l'aide d'un chiffon propre et humide.
- L'utilisation de produits nettoyants chimiques, d'abrasifs ou d'encaustiques sur nos finitions laquées n'est pas recommandée.
- Le matériel de fixation peut se desserrer avec le temps. Vérifiez régulièrement afin de vous assurer que tous les raccords sont bien serrés. Resserrez-les au besoin.

#### Instrucciones de cuidado:

- Limpiar el polvo con un trapo limpio, suave, seco y libre de pelusas.
- Secar los derrames de inmediato y limpiar con un trapo limpio y húmedo.
- Recomendamos no usar limpiadores químicos, abrasivos o lustramuebles sobre el acabado barnizado.
- Las piezas de ferretería pueden aflojarse con el tiempo. Controlar periódicamente que estén bien ajustadas. Si es necesario, volver a ajustarlas.

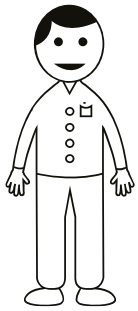

**X2**

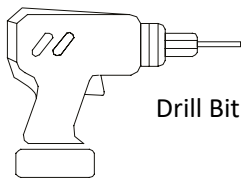
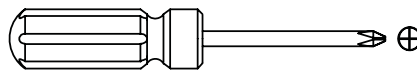
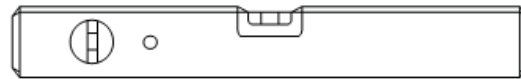
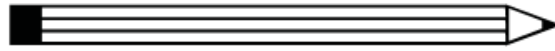

Drill Bit 8 mm

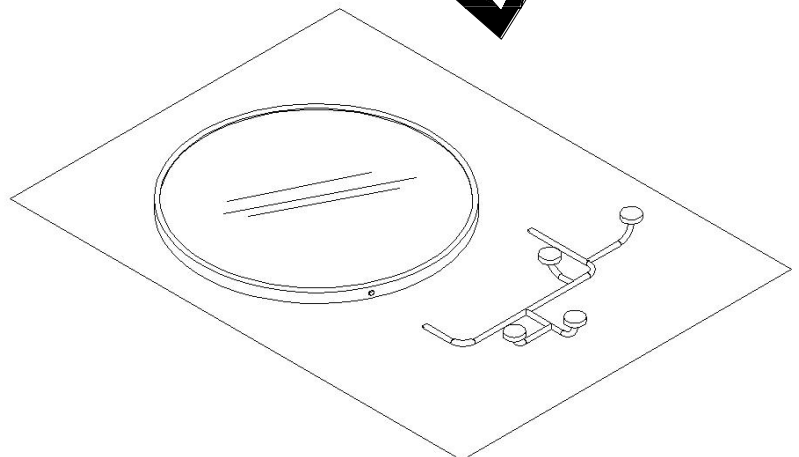
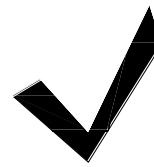
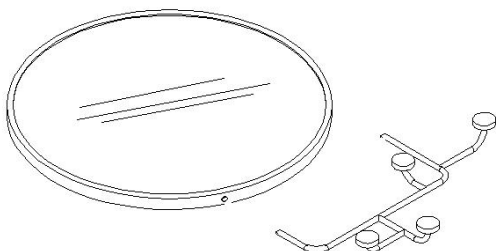
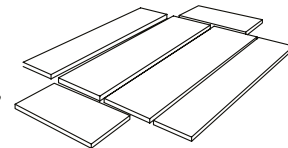
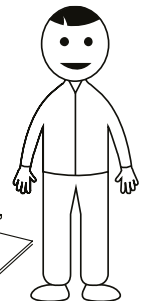
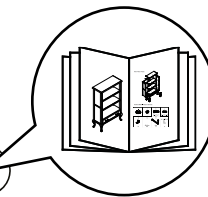
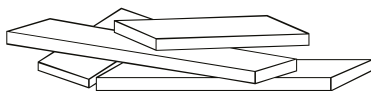
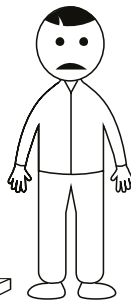
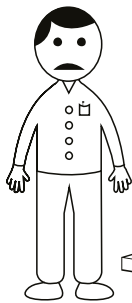
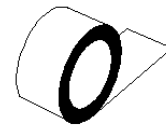

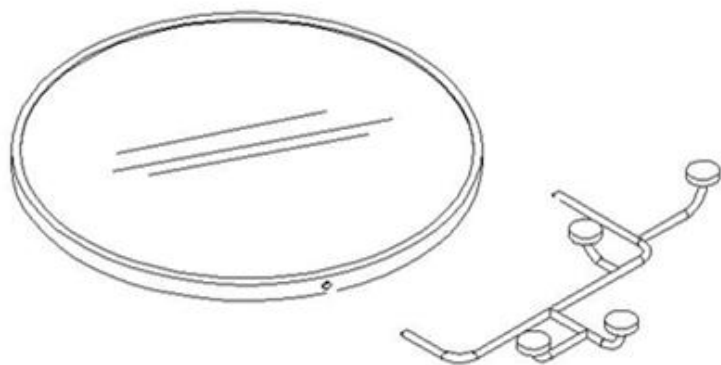

**A**

**1x**

**B**

**1x**



**C**

**2x**

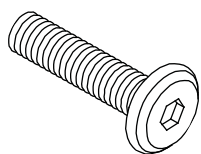

**M6 X 40mm**

**D**

**1x**

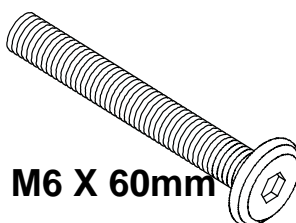

**M6 X 60mm**

**E**

**1x**

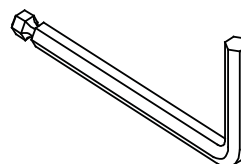

**F**

**1x**



**G**

**2x**



**8 X 1 1/4"**

**H**

**2x**

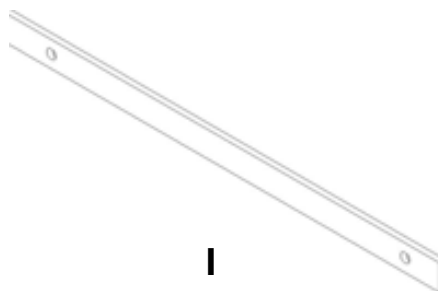

**I**

**1x**

1

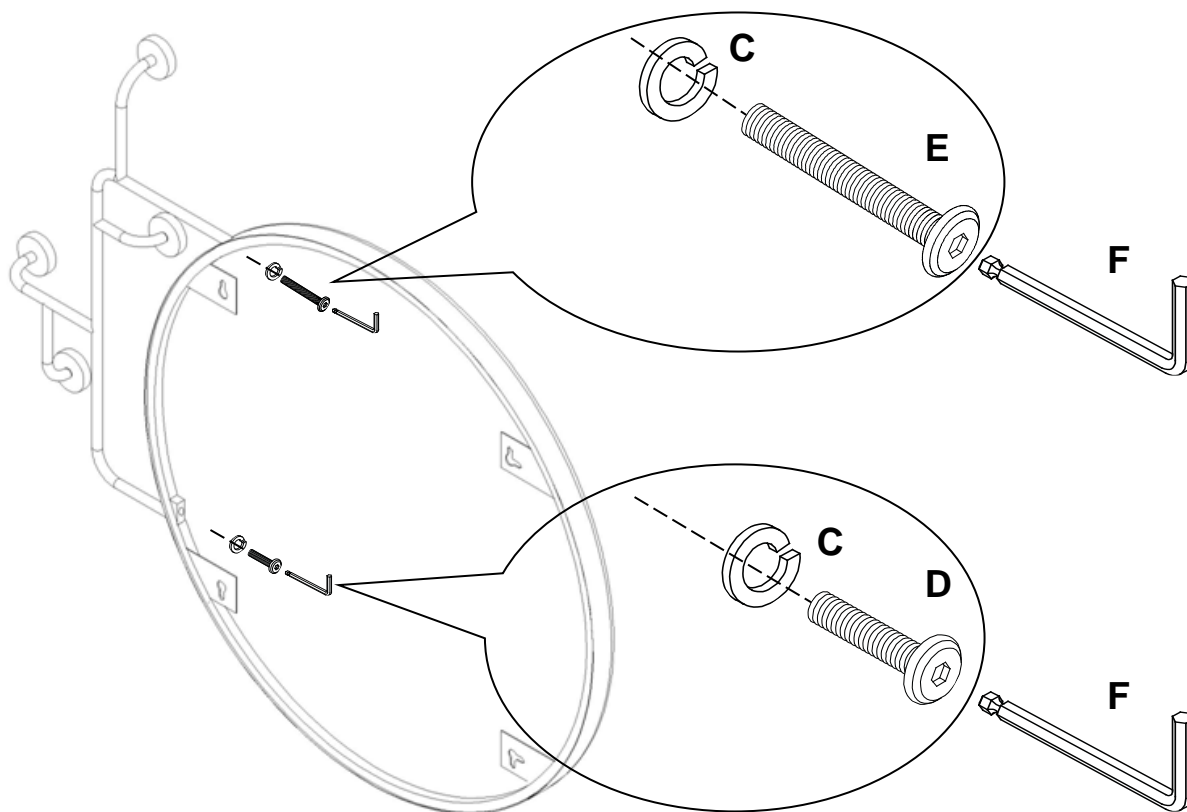

2

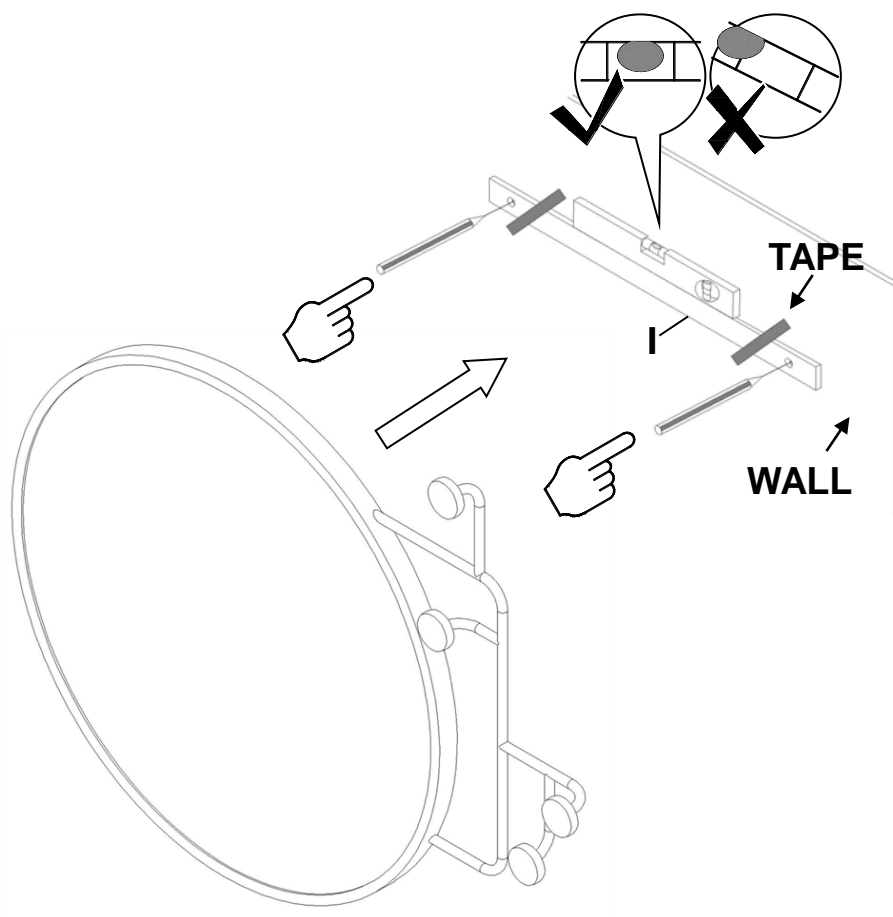

**3**

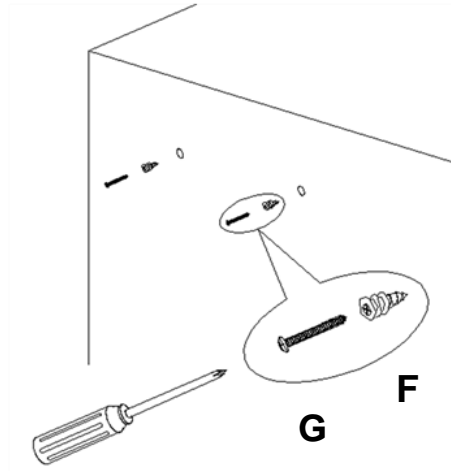
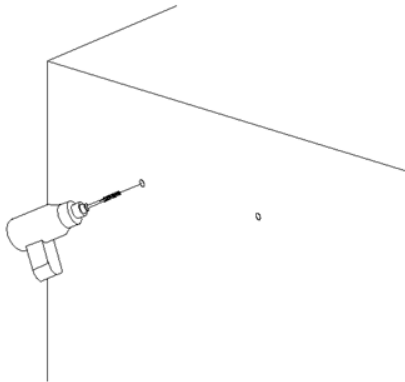

**4**

