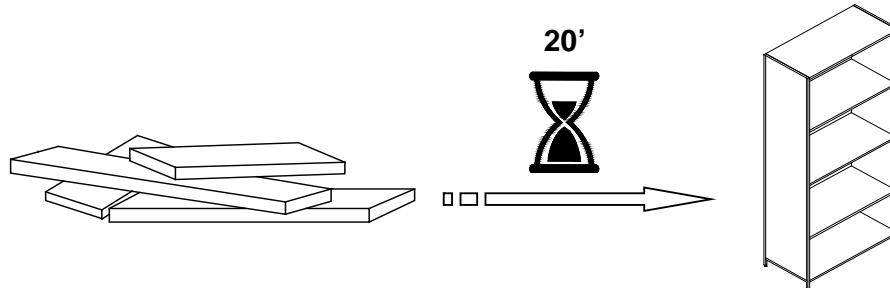

**Roar + Rabbit™ Layered Coffee Table**  
**TABLE DE SALON COUCHES R&R**  
**MESA DE CAFÉ CON CAPAS R Y R**

**! ENGLISH**

- Do not dispose of any packaging or contents of the shipping carton until assembly is completed to avoid accidentally discarding small parts or hardware.

**! FRANÇAIS**

- Ne jetez rien des produits d'emballage et du contenu de la boîte jusqu'à ce que l'assemblage soit terminé, afin d'éviter de jeter par mégarde de petites pièces ou des morceaux.

**! ESPAÑOL**

- Para evitar desechar accidentalmente las partes pequeñas o las piezas de ferretería, no tirar el embalaje o contenido de la caja hasta que el ensamblaje esté completo.

**Care Instructions:**

- Dust often using a clean, soft, dry and lint-free cloth.
- When blot spills, wipe with a clean, damp cloth immediately.
- We do not recommend the use of chemical cleansers, abrasives or furniture polish on our lacquered finish.
- Hardware may loosen over time. Periodically check to make sure all connections are tight. Re-tighten if necessary.

**Instructions d'entretien :**

- Épousseter régulièrement avec un chiffon propre, doux et non pelucheux.
- Éponger immédiatement les liquides renversés et essuyer à l'aide d'un chiffon propre et humide.
- L'utilisation de produits nettoyants chimiques, d'abrasifs ou d'encaustiques sur nos finitions laquées n'est pas recommandée.
- Le matériel de fixation peut se desserrer avec le temps. Vérifiez régulièrement afin de vous assurer que tous les raccords sont bien serrés. Resserrez-les au besoin.

**Instrucciones de cuidado:**

- Limpiar el polvo con un trapo limpio, suave, seco y libre de pelusas.
- Secar los derrames de inmediato y limpiar con un trapo limpio y húmedo.
- Recomendamos no usar limpiadores químicos, abrasivos o lustramuebles sobre el acabado barnizado.
- Las piezas de ferretería pueden aflojarse con el tiempo. Controlar periódicamente que estén bien ajustadas. Si es necesario, volver a ajustarlas.

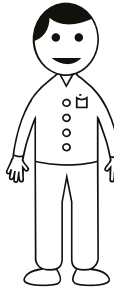

**X2**

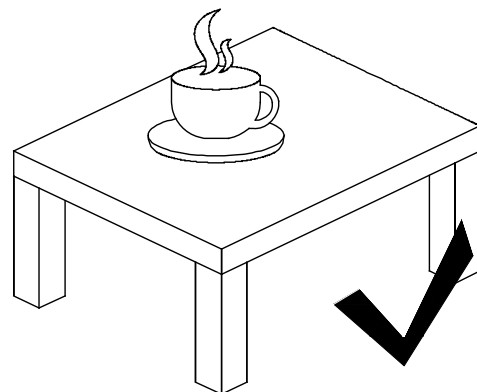
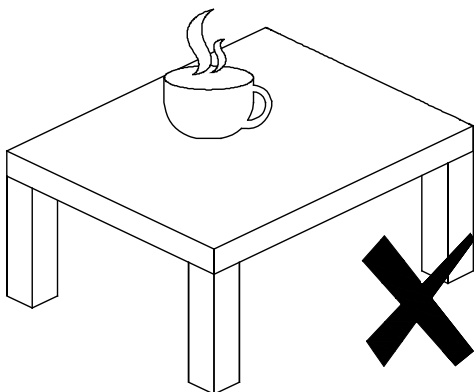
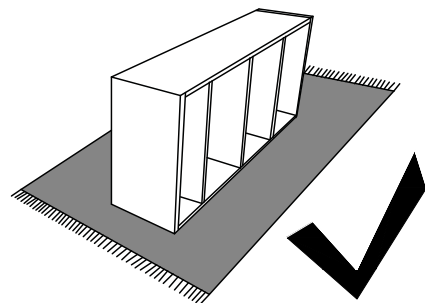
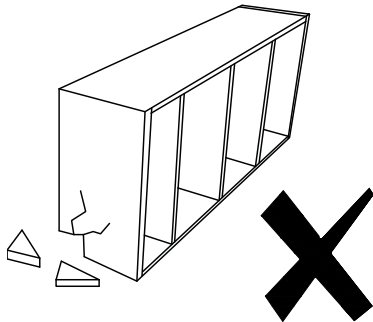
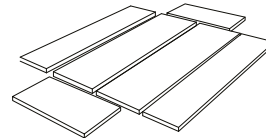
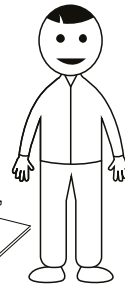
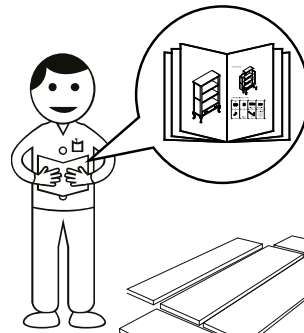
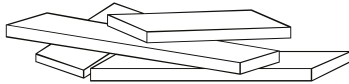
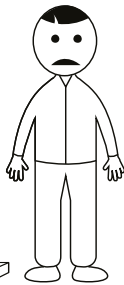
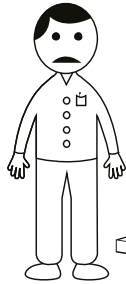
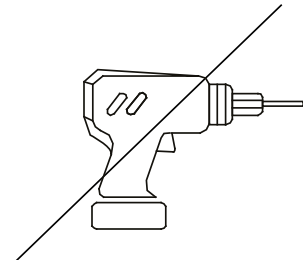
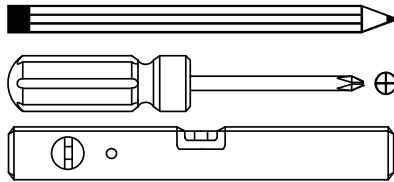

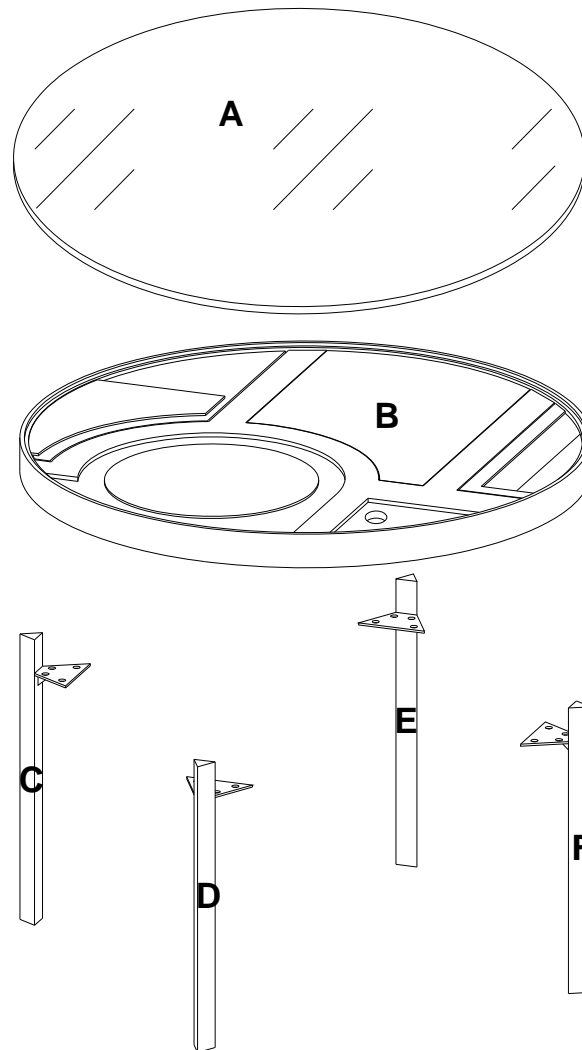

G



Ø18mm x  
Ø6mm, 16x

H



Ø18mm x  
Ø6mm, 16x

I

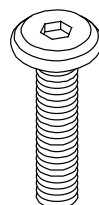

M6x20mm,  
16x

J

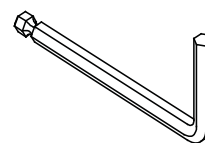

Ø4mmx100mm,  
1x

## 1

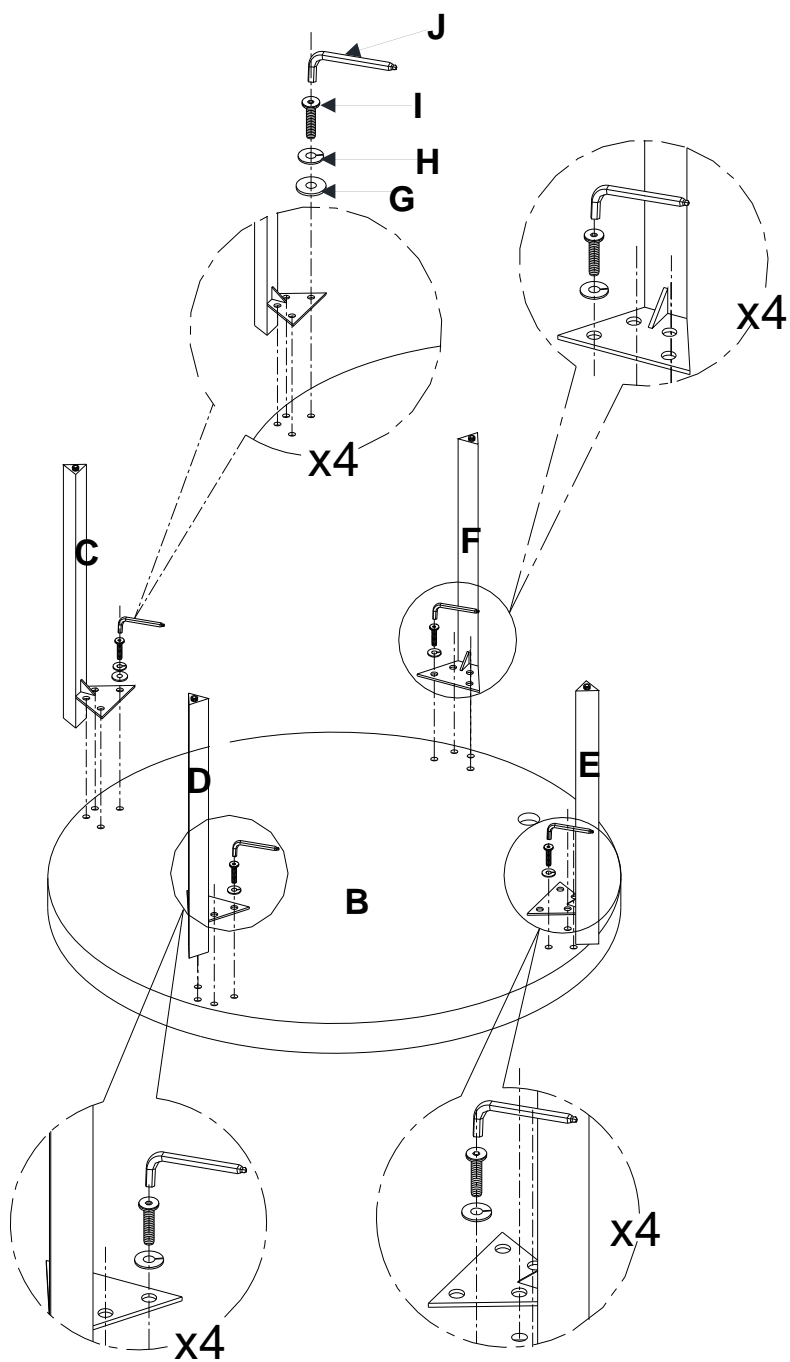

## 2

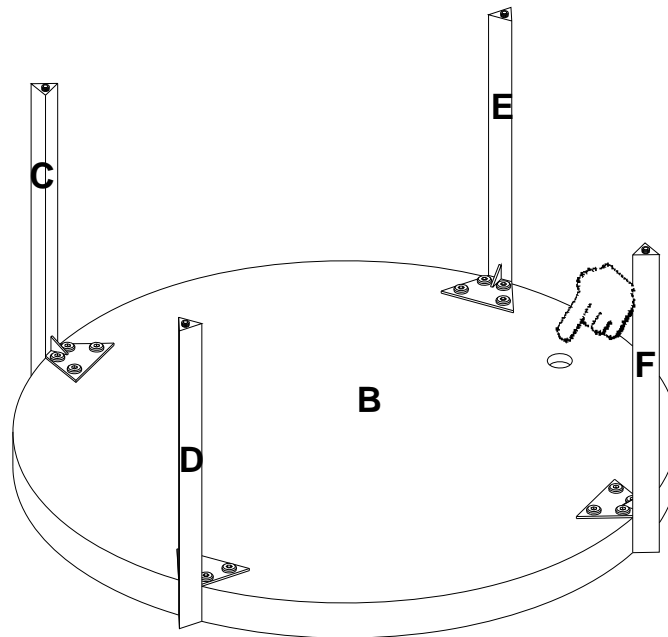

## 3

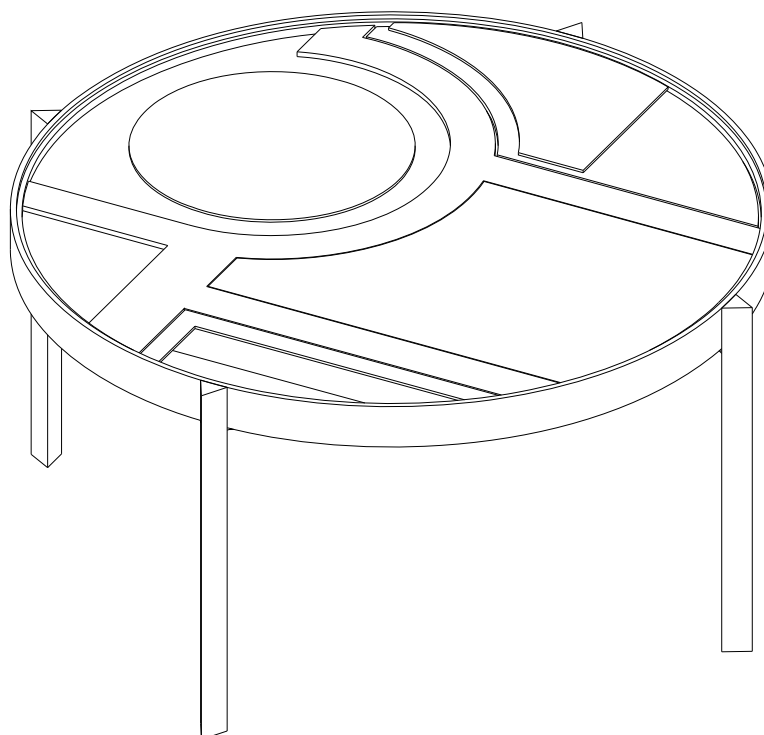

## 4

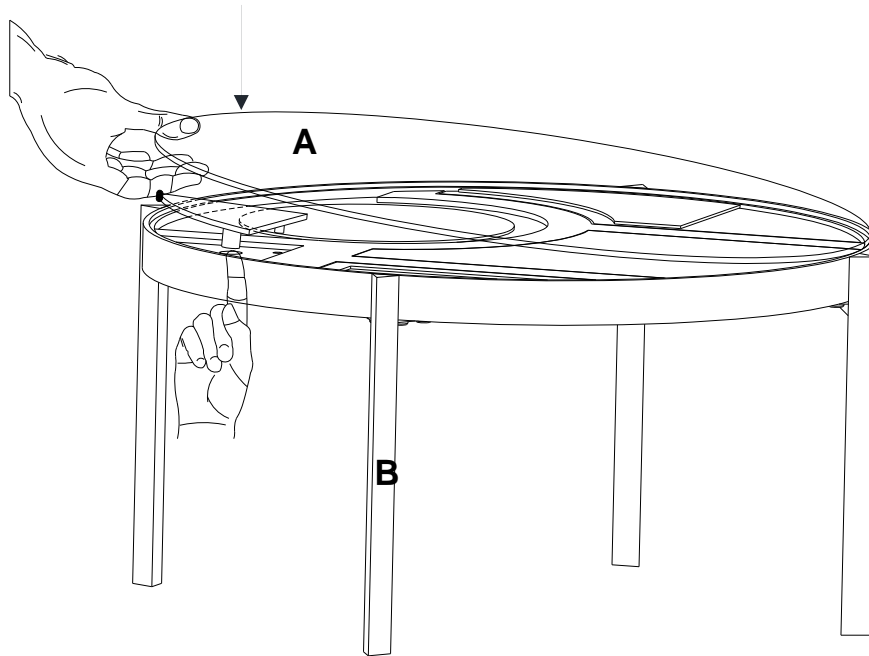

## 5

