

AVERY

74"x36" & 94"x36"

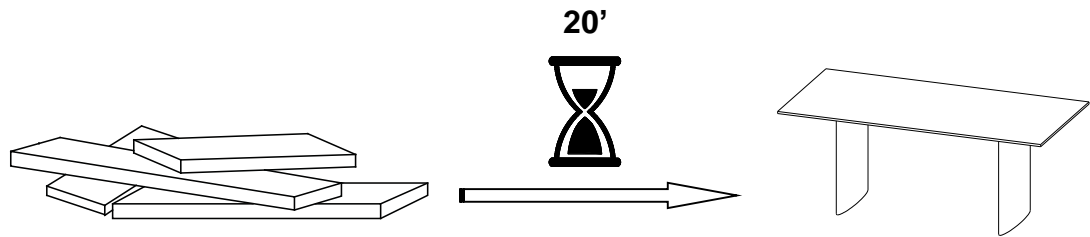

ENGLISH

- Do not dispose of any packaging or contents of the shipping carton until assembly is completed to avoid accidentally discarding small parts or hardware.
- This Base is made for multiple tops, this Assembly Instruction is for Concrete finish top only.

FRANÇAIS

- Ne jetez rien des produits d'emballage et du contenu de la boîte jusqu'à ce que l'assemblage soit terminé, afin d'éviter de jeter par mégarde de petites pièces ou des morceaux.
- Cette base est fabriquée pour plusieurs dessus. Ces instructions d'assemblage s'appliquent à un dessus en béton seulement.

ESPAÑOL

- Para evitar desechar accidentalmente las partes pequeñas o las piezas de ferretería, no tirar el embalaje o contenido de la caja hasta que el ensamblaje esté completo.
- Esta base está hecha para varias tapas. Estas instrucciones de ensamblaje son solamente para el acabado de concreto

Care Instructions:

- Dust often using a clean, soft, dry and lint-free cloth.
- Blot spills and wipe with a clean, damp cloth immediately.
- We do not recommend the use of chemical cleansers, abrasives or furniture polish on our lacquered finish.
- Hardware may loosen over time. Periodically check to make sure all connections are tight. Re-tighten if necessary.

Instructions d'entretien :

- Éponser régulièrement avec un chiffon propre, doux et non pelucheux.
- Éponger immédiatement les liquides renversés et essuyer à l'aide d'un chiffon propre et humide.
- L'utilisation de produits nettoyants chimiques, d'abrasifs ou d'encaustiques sur nos finitions laquées n'est pas recommandée.
- Le matériel de fixation peut se desserrer avec le temps. Vérifiez régulièrement afin de vous assurer que tous les raccords sont bien serrés. Resserrez-les au besoin.

Instrucciones de cuidado:

- Limpiar el polvo con un trapo limpio, suave, seco y libre de pelusas.
- Secar los derrames de inmediato y limpiar con un trapo limpio y húmedo.
- Recomendamos no usar limpiadores químicos, abrasivos o lustramuebles sobre el acabado barnizado.
- Las piezas de ferretería pueden aflojarse con el tiempo. Controlar periódicamente que estén bien ajustadas. Si es necesario, volver a ajustarlas.

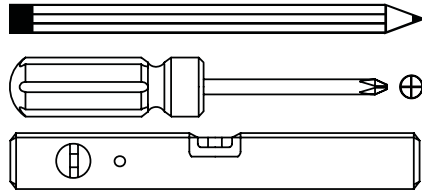
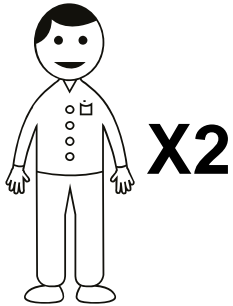

NOT INCLUDED / NON INCLUS / NO INCLUIDAS

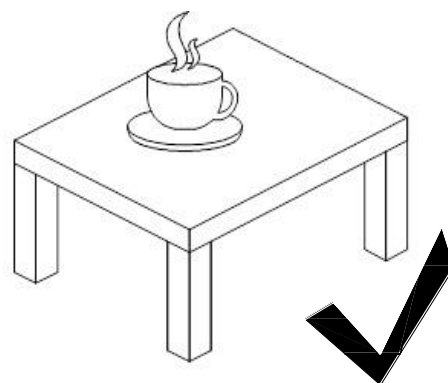
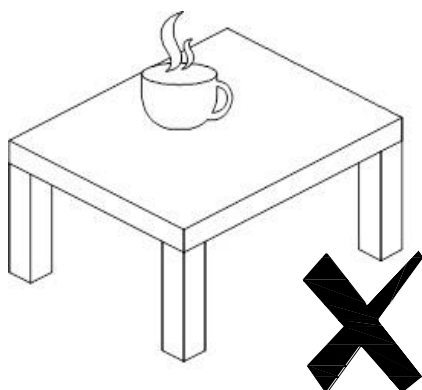
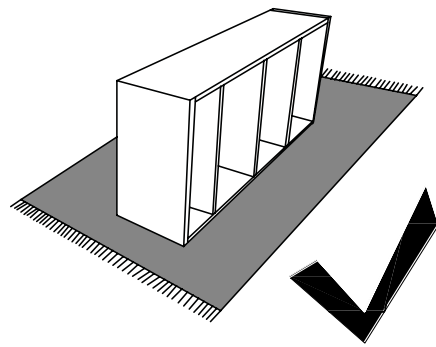
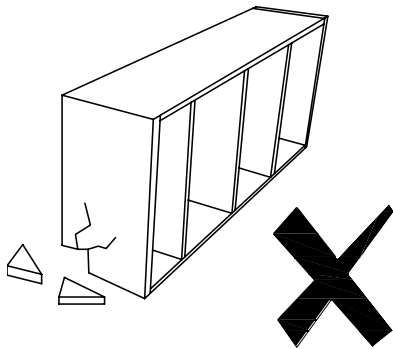
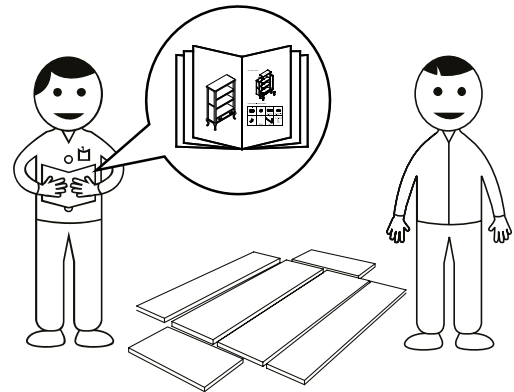
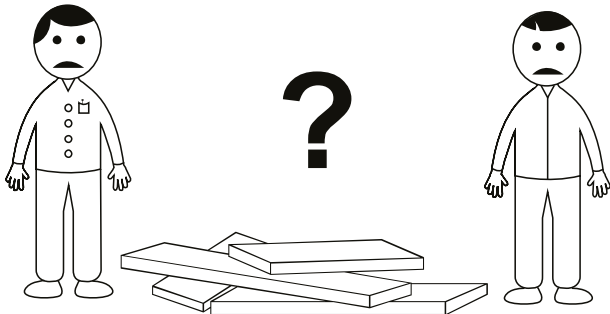
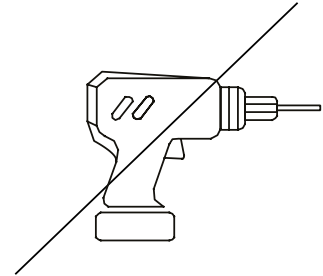

OPTION - 1 (CONCRETE FINISH TOP)

(DESSUS EN BÉTON)

(TAPA DE ACABADO DE CONCRETO)

74"x36" & 94"x36"

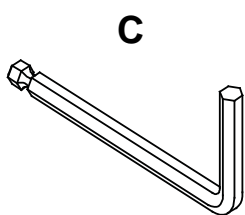
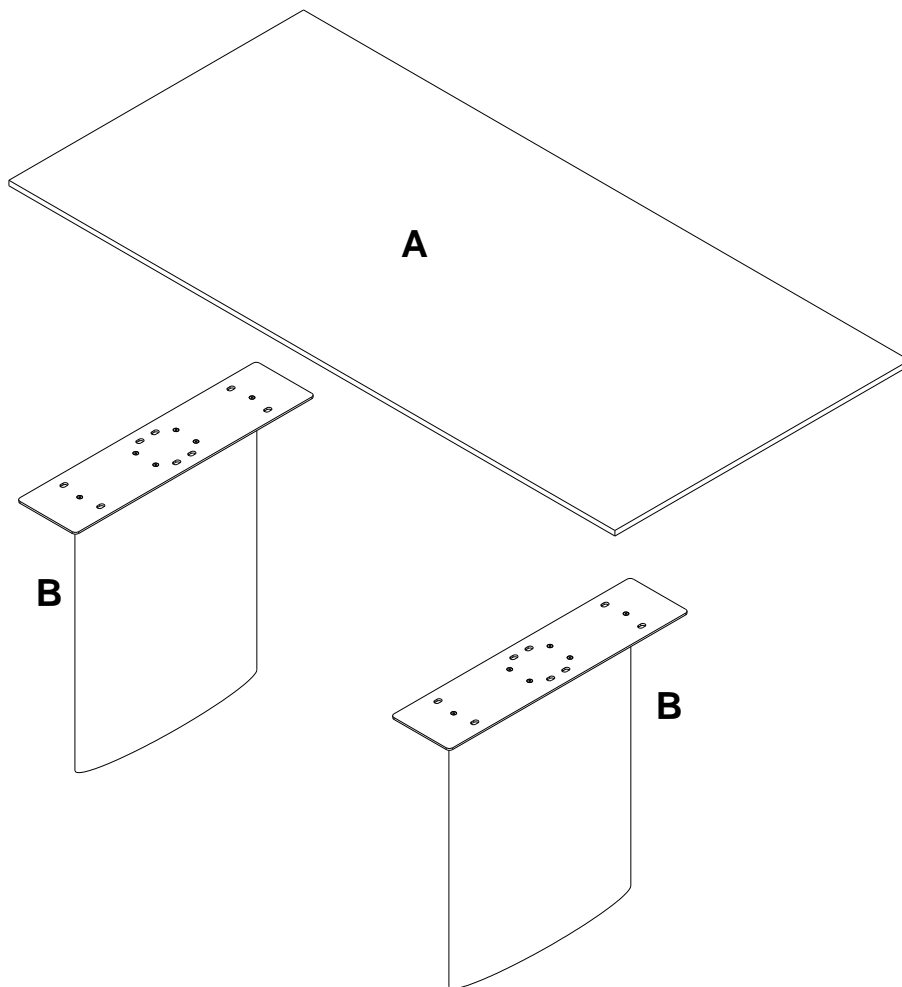

M4 x 140mm

1x

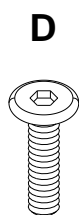

M6 x 20mm

16x



Ø15 x ø8mm

16x

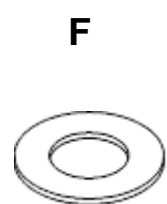

Ø22 x ø8mm

16x

1.1

CONCRETE FINISH TOP DESSUS EN BÉTON TAPA DE ACABADO CONCRETO

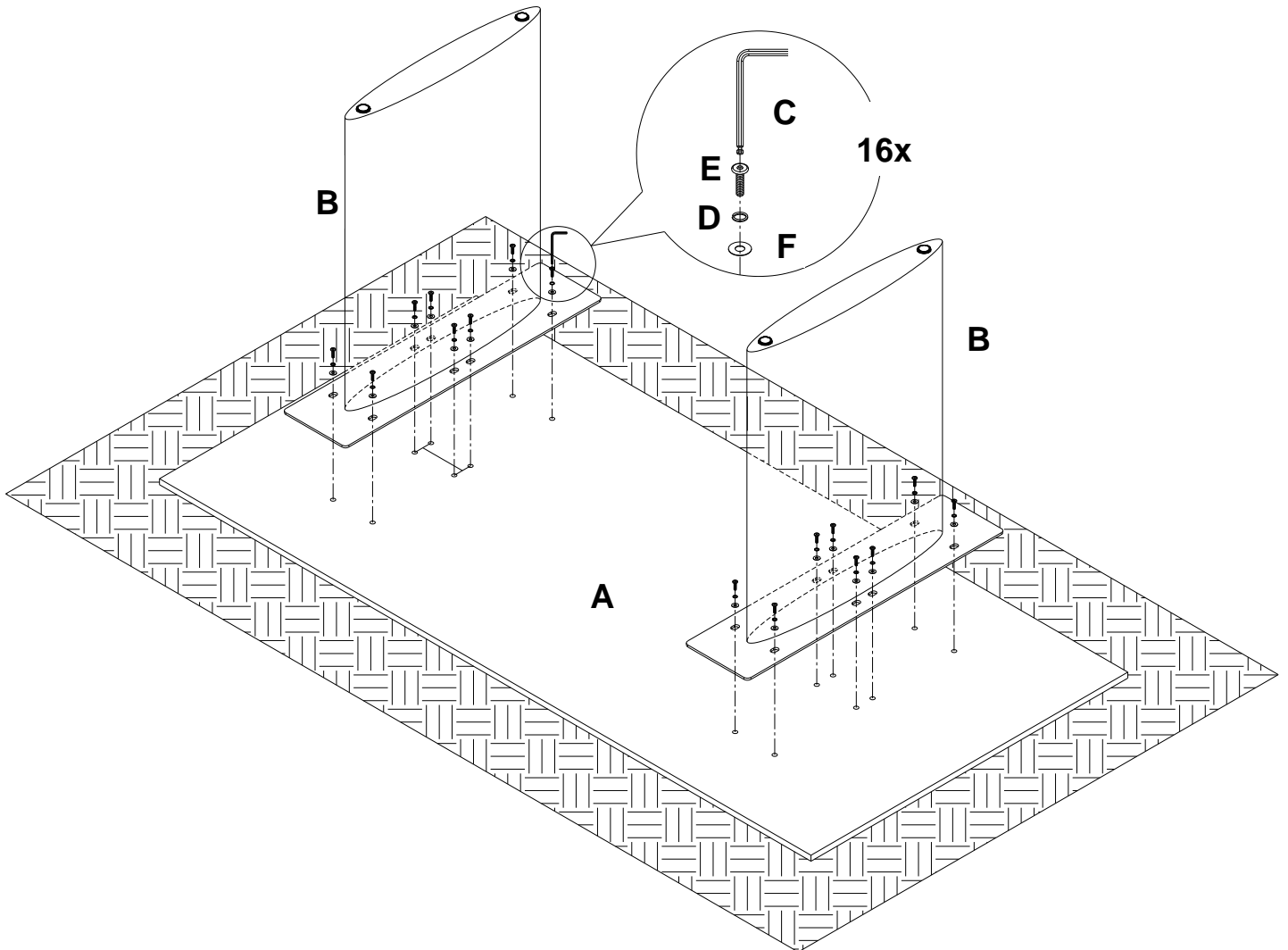
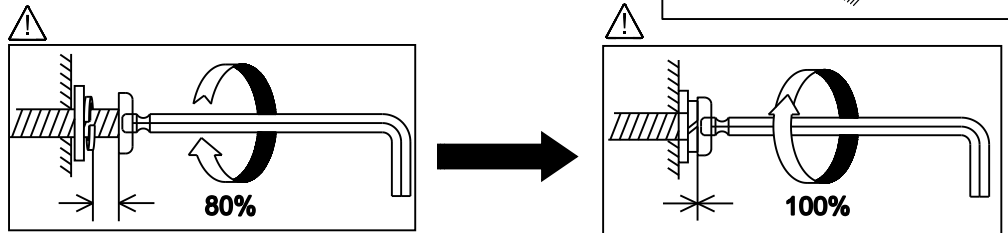
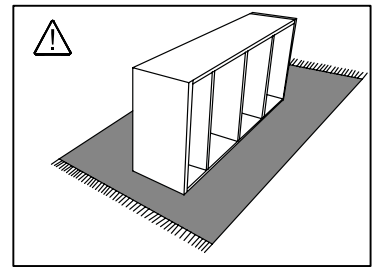

1.2

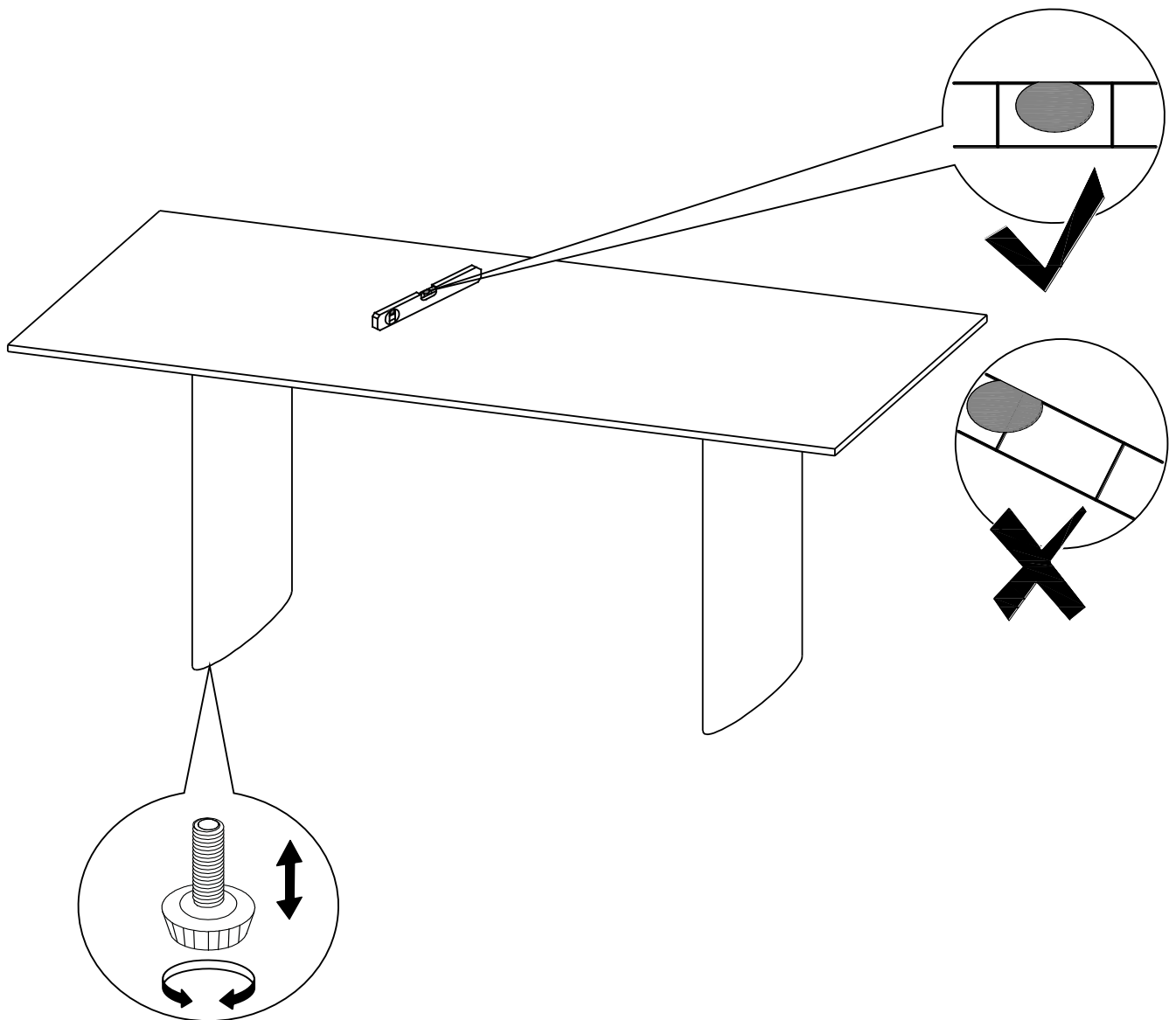

OPTION – 2 (WOOD TOP)

(DESSUS EN BOIS)

(TAPA DE MADERA)

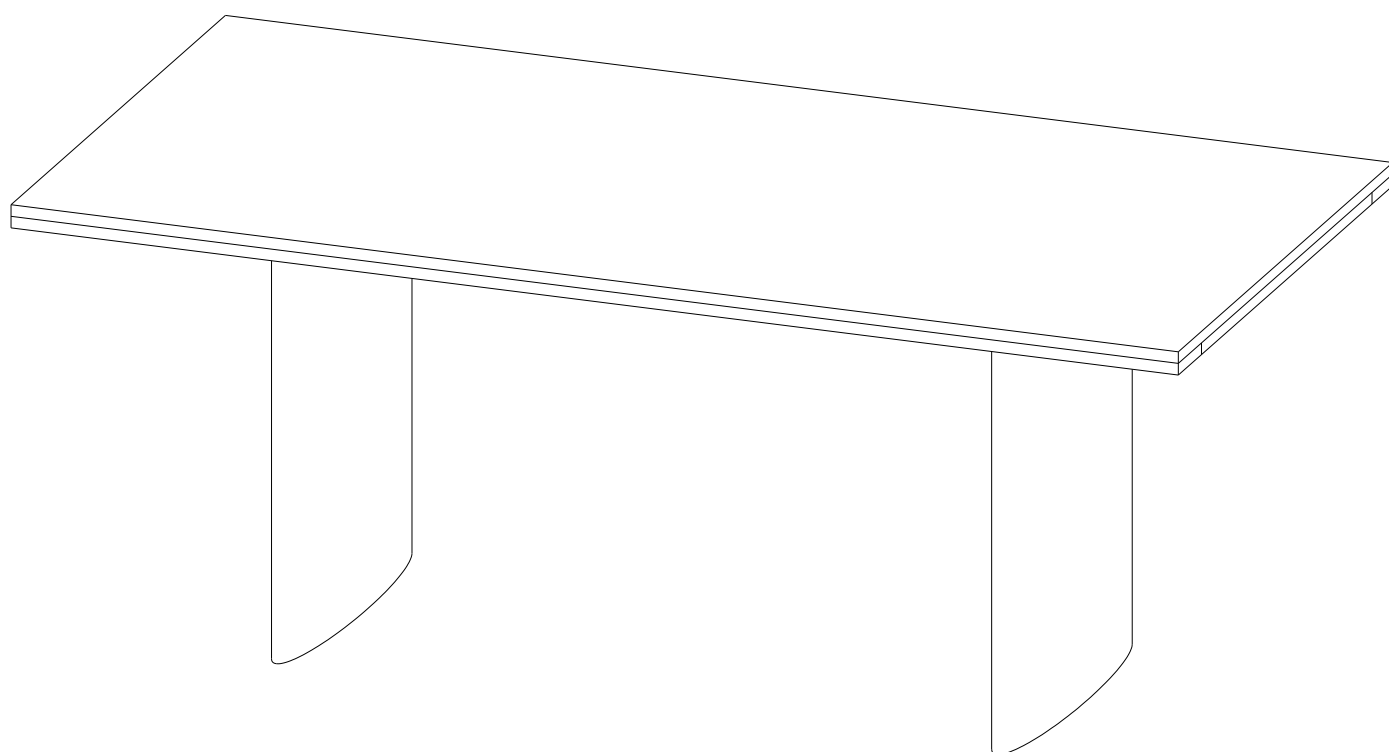

- **Please refer Assembly Instructions provide with Wood Top.**
- **Consulter les instructions d'assemblage fournies avec le dessus en bois.**
- **Consultar las instrucciones de ensamblaje que se proporcionan con la tapa de madera.**